



CABLE REEL serie 4000

Manufactured according to standard:
Construit selon norme:
EN 61242 EN 60335-1



These products comply with Directives:
Produits conformes aux Directives:
2006/95/CE 2006/42/CE 2002/95/CE



OPTIONAL

ART. 949/804-4000

- Optional device to make the fastening bracket fixed instead of pivoting. Essential for 7 and 8 set-ups according to p. 106.

- Dispositif optionel pour rendre fixe au lieu d'orientable le support de fixation et indispensable pour l'application selon les schemas 7 et 8 à page 106.

- Optionsvorrichtung um den Befestigungsbügel der Kabelaufroller fest statt schwenkbar zu machen. Sie ist unentbehrlich für die Installation nach den Schemen 7 und 8 auf Seite 106.

- Dispositivo opcional par hacer fijo, en vez que orientable, el estribo de fijador de los envolvedores. Indispensable para la aplicación según los esquemas 7 y 8 a pag. 106.



REEL FEATURES

- Shock resistant plastic external case
- Cable roller guide
- Ratchet stop device every 50 cm., easily removed if constant traction of cable is required
- Double earth contact
- Collector insulating power 2,5 Kv.
- Slipping with brass rings and brushes
- Protection degree IP42
- Working temperature -5°C/+40°C
- Delivered without cable at feeding side
- Available both with PVC cable and rubber cable.



CARACTERISTIQUES DE L'ENROULEUR

- Boîtier en plastique antichoc
- Dispositif guide-câble à rouleaux
- Cliquet d'arrêt applicable tous les 50 cm., facile à dégager lorsqu'on désire le câble toujours en traction
- Double contact de terre
- Tension d'isolation du collecteur 2,5 Kv
- Collecteur à bagues en laiton et brosses
- Degrée de protection IP42
- Température d'utilisation -5°C/+40°C
- Livrés sans câble coté alimentation
- Disponibles avec câble PVC et en caoutchouc







EIGENSCHAFTEN AUFROLLER

- Außengehäuse aus schlagfestem Kunststoff
- Kabelführungsöffnung mit Rollen
- Kabelrücklaufperre mit Zahnarretierung alle 50 cm, leicht auszuschalten, falls das Kabel kontinuierlich in Anspannung sein soll
- Doppelter Erdungskontakt
- Schleifring Isolierungsspannung 2,5 Kv
- Schutzart IP42
- Umgebungstemperatur -5°C/+40°C
- Geliefert ohne Kabel an der Zuführungseite
- Lieferbar mit PVC und Gummikabel





CARACTERISTICAS DE L'ENROLLADOR

- Elementos estructurales de material plástico antigolpes
- Boca guía del cable a rodillo
- Dispositivo de parada del cable a cremallera, ajustable cada 50 cms. y de fácil eliminación en caso que se quiera el tubo en constante tracción
- Doble contacto de tierra
- Tensión de aislamiento des colector 2,5 Kv
- Contactos de arrastre con anillo recolector y escobillas
- Grado de protección IP42
- Temperatura ambiente de utilización -5°C/+40°C
- Provisto sin cable en lado alimentación
- Disponibles con cable PVC y con cable en goma

Number of conductor Nombre des conducteurs Anzahl der Leiter Número de conductores	Conductors section, sqmm Section des conducteurs en mm ² Querschnitt der Leiter, qmm. Sección des conductores	Metres of coiled cable Mètres de câble enroulés Aufgerollte Kabellänge in Metros de cable enrollado	Art.	KW		Cable diameter, mm. Diamètre du câble mm Durchmesser des Kabels Diámetro cable mm.	Thermal protector	V max	cable type			
				 (20°C)	 (20°C)							
1 x	6	15 + 1	4106			5,5	no		H05 V-F 			
	16	10 + 1	4116			8	no		H05 V-F 			
2 x	1	17 + 1	4210	230V	0,9	1,4	6,5	yes/oui	500	H05 VV-F		
		12 + 1	4210 RNF				8,5	yes/oui	750	H07 RN-F		
	1,5	4215	1,1			1,6	7,5	yes/oui	500	H05 VV-F		
3 G	1,5	14 + 1			4315		230V	1,2	1,8	8,5	yes/oui	500
		9 + 1			4315 RNF	10				yes/oui	750	H07 RN-F
	2,5	4325	1,9		2,5	10			yes/oui	500	H05 VV-F	
7 + 1	4325 RNF	12		yes/oui		750		H07 RN-F				
4 G	1,5	10 + 1	4415	400V	1,4	1,9		9,5	no	500	H05 VV-F	
		8 + 1	4415 RNF					11	no	750	H07 RN-F	
	2,5	4425	2,0			2,7	11	no	500	H05 VV-F		
5 + 1	4425 RNF	13			no		750	H07 RN-F				
5 G	1	10,5 + 1			4510	400V	1,0	1,5	9	no	500	H05 VV-F
	1,5	8 + 1	4515		1,9				10,5	no	500	H05 VV-F
		7 + 1	4515 RNF	12				no	750	H07 RN-F		

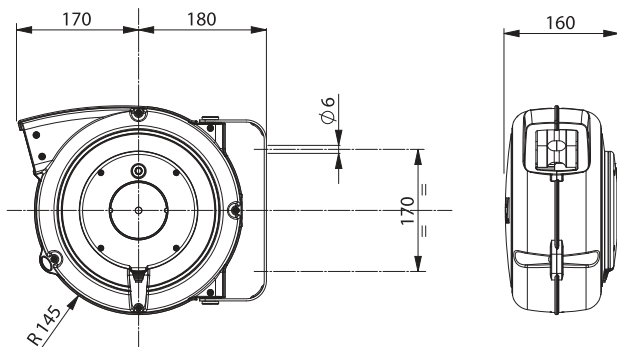
DIMENSIONS



	44
	mm 335x310x185 Kg 5

SPECIAL VERSION - SEE AT PAGE 45-46-47

CABLE REEL WITH SCHUKO PLUG AND SOCKET
 ENROULEUR POUR CABLE COMPLET AVEC PRISE ET FICHE SCHUKO
 KABELAUFWOLLER MIT SCHUKOSTECKER UND STECKDOSE
 ENROLLADOR DE CABLE CON PLACA Y TOMA SCHUKO

Art. 4315/GS YELLOW COLOUR

Art. 4315/S GS GREY COLOUR

